



[www.draminski.com](http://www.draminski.com)

# GRAIN MOISTURE METER DRAMiNSKI GRAIN MASTER (GMS)

EN



Instruction manual

ISO 9001 | CE

# CONTENTS

	INTRODUCTION.....	3
SECTION 1	COMPONENTS .....	5
SECTION 2	PRODUCT DESCRIPTION .....	7
SECTION 3	KEYBOARD FUNCTIONS .....	11
SECTION 4	DEVICE OPERATION .....	13
SECTION 5	INSTRUCTIONS FOR MEASUREMENTS .....	17
SECTION 6	MEASUREMENTS.....	21
SECTION 7	LIST OF AVAILABLE SPECIES AND ADDING NEW TYPES OF GRAIN.....	25
SECTION 8	UPDATING VIA USB .....	27
SECTION 9	MODIFICATION OF MOISTURE INDICATIONS .....	29
SECTION 10	SETTINGS.....	33
SECTION 11	BATTERY REPLACEMENT .....	41
SECTION 12	FINAL NOTES .....	43
SECTION 13	TECHNICAL DATA.....	45



# INTRODUCTION

EN

Thank you for purchasing new Dramiński Grain Master grain moisture meter. This excellent device will be very useful in your activity. Thanks to special design and ability to grind the sample, grain moisture is accurately determined.

Innovative solutions, state-of-the-art technology and great versatility due to the possibility of updating through the USB port, make it a good long-term investment.

Increase your crops and enjoy your work with the Dramiński GMS grain moisture meter.

The manufacturer – DRAMIŃSKI S.A. offers its users great knowledge and reserves the right to introduce hardware and firmware modifications. DRAMIŃSKI S.A. reserves the right to amend the contents of this instruction manual.

Read this instruction manual thoroughly before putting this device into operation. It will guarantee the safety of operation as well as long and reliable functioning of the device.

Declaration of conformity is available for review at the seat of DRAMIŃSKI S.A. at 17 Owocowa st., 10-860 Olsztyn, POLAND

The manufacturer provides warranty and post-warranty service in Poland. For more information and data, visit our website [www.draminski.pl](http://www.draminski.pl)

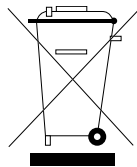

Please note that electronic equipment and batteries must not be disposed of in household waste containers. Used equipment and appliances should be delivered to special disposal facilities, according to the valid regulations. Proper waste disposal helps to save the natural environment.

# COMPONENTS

EN

## SECTION **1**

## COMPONENTS:

1. transport case with foam
2. Dramiński GMS moisture meter
3. rubber dust cup of mini-USB port
4. 24 mm cap (dispenser)
5. instruction manual
6. measuring chamber knob
7. ratchet wrench
8. USB cable to communicate with PC
9. plastic brush to clean the measuring chamber (with a handle)
10. plastic brush to clean the measuring chamber
11. 1 battery, type 6LF-22, 9V



# PRODUCT DESCRIPTION

EN

## SECTION **2**



## PRODUCT DESCRIPTION

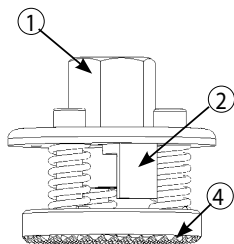
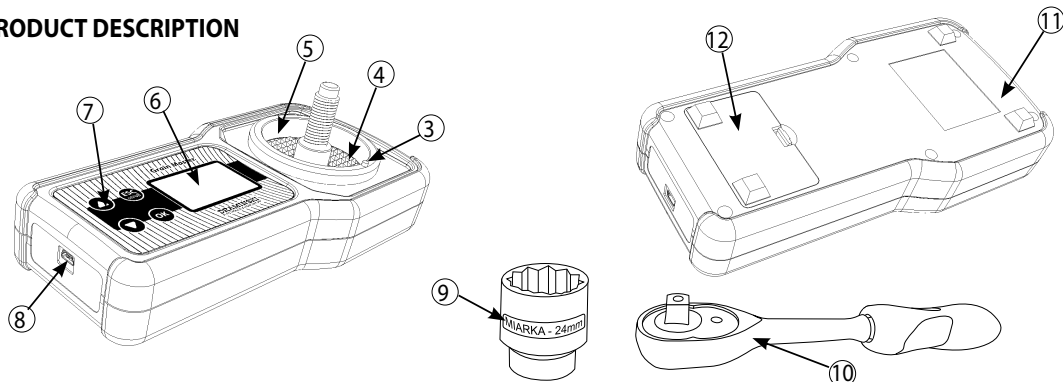

1. measuring chamber knob
2. knob's block system
3. knob's block system limit
4. grinding device
5. measuring chamber with built-in digital temperature sensor
6. LED backlight graphic LCD display
7. membrane keyboard
8. mini-USB port with a rubber cup
9. dispenser to measure the volume of the sample (24 mm cap)
10. ratchet wrench
11. heavy duty ABS plastic casing
12. battery compartment for 1 battery type 6LF-22.9V

## APPROXIMATE DIMENSIONS

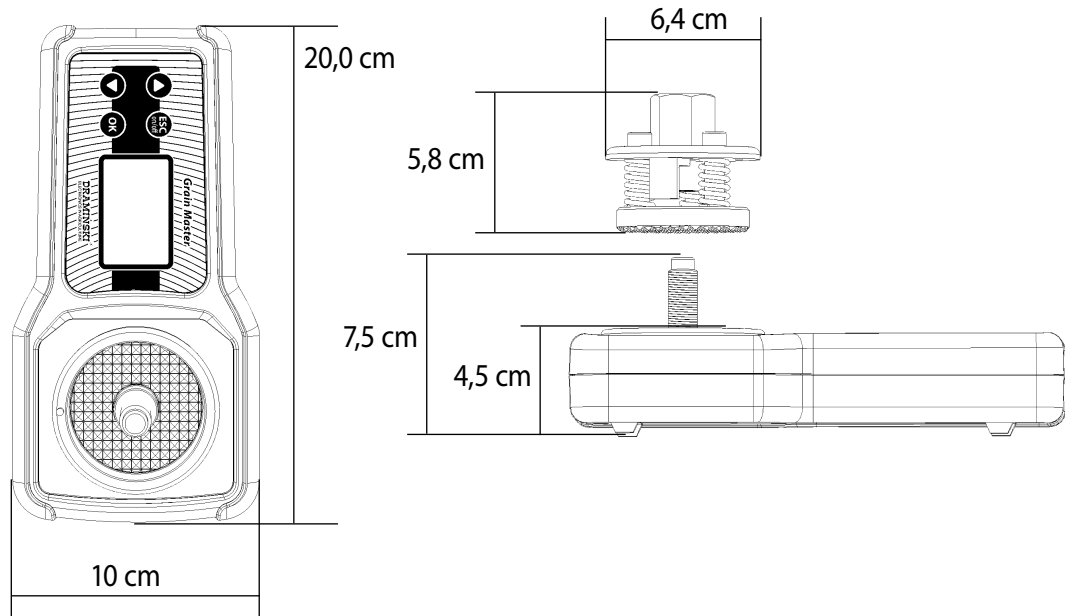

EN





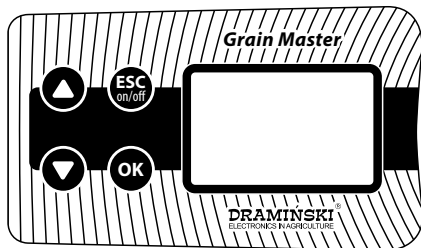

# KEYBOARD FUNCTIONS

EN

## SECTION **3**



	<ul style="list-style-type: none"> <li>- switch on</li> <li>- switch off – hold for 5 seconds (<i>Note! GMS can be switched off using option “Shut-down!” in the main menu, if the device is not used, it switches off automatically in order to save the source of energy)</i></li> <li>- switch on main menu – hold for 2 seconds</li> <li>- program function clear</li> </ul>
	<ul style="list-style-type: none"> <li>- program function confirm</li> <li>- start measuring</li> </ul>
	<ul style="list-style-type: none"> <li>- menu scrolling</li> <li>- setting values of menu options</li> <li>- grain selection from the list</li> </ul>
	<ul style="list-style-type: none"> <li>- delete average result when measuring moisture of the given sample</li> </ul>

# DEVICE OPERATION

EN

## SECTION 4

The GMS is ready for operation if a battery in the battery compartment is properly inserted (pay attention to polarity).

Switch the device on with the help of the  button.

a) you will hear 1 short sound signal and then greeting text appears on the screen which shows the name of the device, firmware version, calibration version and serial number, e.g.:



b) then there appears a list of available species and in the upper part of the device there appears model of the device, battery level (when the device switches on, it shows the last tested species), e.g.:

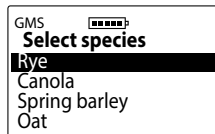

Note! If the battery is discharged to continue operation, the device automatically signals it with a message:

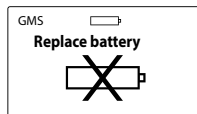

which means that you have to insert a new battery;

c) in order to save batteries, when no key is pressed for a certain time, the device will go to a standby mode and the backlight will turn off (that time can be changed through the proper menu option – see SETTINGS section). Press any button to return to the operation mode;

- d) if the GMS remains in the standby mode for several minutes, it will shut down automatically (time setting possible in menu). Then you will hear a short sound signal informing that countdown from 10 to 0 is displayed on the screen – press any button to stop, or the device will switch off automatically to save power, e.g.:



- e) e) for manual switch off, hold  button for 5 seconds or select “**Shutdown!**” in the main menu.





# INSTRUCTIONS FOR MEASUREMENTS

EN

## SECTION **5**

- in order to measure proper volume of grain use the cap with 24 mm screw which is used as dispenser as well. You should take one full dispenser, spread the grain on the grinding mechanism of the measuring chamber and tighten the knob of the chamber until it stops on the knob's block system limit extending from the measuring chamber. **After that select the species from the list of the device and start measuring pressing  button;**
- **measuring the sample with the dispenser and tightening the knob properly is necessary in order to obtain accurate results;**
- the measuring chamber should be thoroughly cleaned especially when you change the species of grain and when the samples have different, usually increased moisture;
- grinding device should be thoroughly cleaned after measuring samples which have increased humidity;
- if humidity is increased (more than 25%), it is necessary to avoid the situations when too cold grain is inserted into the chamber, because water vapour condenses on the surface of the grain. In these situations it is necessary to mix the grain properly, take the sample and wait a few minutes until the temperature of the grain increases. Moreover, the first measuring result should be ignored, the final result should consist of an average result of the following three measurements;
- when mounting the knob on the threaded shaft of the measuring chamber, you should pay special attention to proper interlocking of the thread;

- **size of grains and purity of test sample determine obtainment of a correct result. Chaff, screenings and dirt content within the sample should be as low as possible;**
- water remaining on top of the sample (e.g. dew) can affect measurement result. Samples should be **aired** before measurement to avoid it;
- the final result of measuring should be the average value of e.g. 3 recent tests of a given sample, which is calculated automatically and displayed in the bottom right corner of the screen (number of measurements used for calculation of the average value can be changed in the menu);
- make sure that the measuring chamber temperature is the same as the sample temperature (do not pour cool grain into the hot device (e.g. after being exposed to sunlight and vice-versa).

The temperature sensor may react with a time-lag because of metal parts of the measuring chamber.

- every species has a different range of moisture; however, when it is exceeded, it is signaled with a particular sign, e.g.:

“<**8.5%**” (below the range), when the sample’s moisture is less than 8.5%,

“>**35.0%**” (over the range), when the sample’s moisture is more than 35%,

- if significant departures are found in the result for a given species, either too high or too low by a similar value within the entire measurement range in comparison with the drying-and-weighing test method, indications must be modified;

- **to clean the measuring chamber and the grinding device use the brushes made of plastic enclosed to the set, using metal brushes may damage the surface of the grinds, which may have a considerably negative influence on the measuring results.**

# MEASUREMENTS

EN



## SECTION 6

## In order to carry out grain moisture measurements you have to:

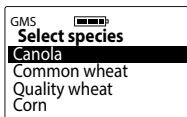
- a) switch the device on using  button, after a short introductory information a list of available species appears. The GMS usually highlights the name of the species previously tested, for example: „**Canola**”



- b) fill in the measuring chamber with full dispenser of the tested grain (dispenser is enclosed to the set);
- c) put the knob of the measuring chamber on the threaded spindle paying attention to proper threading. Then manually tighten the knob so that it had contact with the grain;

- d) put the ratchet wrench on the hexagonal spindle of the knob, set the switch of the wrench direction properly and tighten the knob until it is totally blocked. During grinding you should hold the device strongly;
- e) when this is done, you should select the species using  or  buttons and start measuring using  button;
- f) after confirmation you will hear 1 short sound signal informing that the measurement begins, and on the screen you will see a message “**Measuring in progress...**” and the progress bar, e.g.:

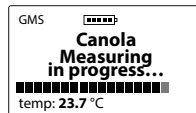
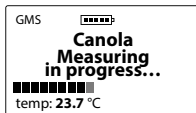

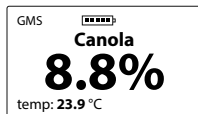

**During this time you should not touch the measuring chamber.**

- g) after a few seconds you will hear 2 short sound signals informing that the measuring has finished, the screen will show moisture result in % and temperature of the sample (in °C or °F depending on settings), e.g.:



Moisture measurement result is presented taking into consideration correction for temperature (automatic temperature compensation).

- h) when the measuring has finished, you should remove the knob from the measuring chamber using the ratchet wrench (use the switch of direction), then empty and clean the grinding device and the knob with the help of the plastic brushes. When the measuring chamber is clean, the device is ready for further operation. In order to measure another sample of the same species, grind the

grain again and then start measuring with  button, or using  button to go back to the list and choose another species;

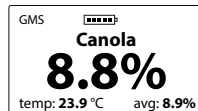

**NOTE!** Proper clearing of the measuring chamber is required when you change the type of grain and when the samples have different or increased humidity.

- i) the final result should be an average of at least 3 measurements. The GMS automatically calculates the average and shows it in the bottom right corner of the screen, for example:



The number of measurements from which the average value is calculated can be changed in the main menu (see section: SETTINGS).



The results above and below the range are not taken into consideration when the average value is calculated. In order to calculate the average result from the beginning, you can clear it up with the help of  button or go back to the list of species with the help of  button;

j) when the measurements are performed, in order to save the battery you should switch the device off holding the  button for 5 seconds or with the help of **“Switch off!”** option available in the main menu.

# LIST OF AVAILABLE SPECIES AND ADDING NEW TYPES OF GRAIN

EN

## SECTION **7**

The Draminski GMS grain moisture meter is capable of storing in its memory a few hundred different types of grain to be used in measurements. The list of available species may vary in each device, depending on current offer in the country of purchase.

Current list of all available species is available on the manufacturer's website **www.draminski.pl** in **Products / Grain moisture meters / Dрамиński GMS**

Users of the Draminski GMS moisture meters may activate additional species by entering a special code in the main menu, after selecting the option "**Add species**" (see: SETTINGS). In order to get the special activation code for a chosen grain type, please, contact us:

**e-mail: wilgo@draminski.com**

**phone: +48 89 527 11 30**

or contact the nearest authorized Dрамиński S.A. distributor.

Contact us if you have a grain type not included in the list on our website or a special grain type that you would like to test. We are open for remote cooperation to add new species configured according to your needs, that could be activated in your device using a special code.

These unique possibilities make the GMS a universal device that will offer its unlimited capabilities even after many years of use.

# UPDATING VIA USB

EN

## SECTION 8

The Draminski GMS is equipped with a mini-USB port that allows the user to update the firmware, data stored in the device memory, list of available language versions and also activate new functions of the device, or change the list of available species.

Check availability of new updates on the manufacturer's website **www.draminski.pl** in **Products / Moisture Meters / Dramiński GMS**

To get through the update procedure, follow the step-by-step guide available on our website.

Our programmers have strived for making the update as easy as possible, so even most inexperienced users will be able to do it.

In case of any questions and doubts do not hesitate to contact our specialists.

**e-mail: wilgo@draminski.com**

**phone: +48 89 527 11 30**

# MODIFICATION OF MOISTURE INDICATIONS

EN

## SECTION 9

The Draminski GMS grain moisture meter stores moisture curves for each species, determined on the basis of results for normalised samples (bulk density of grain and mass of 1000 seeds), which guarantees accurate and repeatable results. However, it may happen that crop of a given year varies from normalised seeds (due to various factors) and departures may occur in moisture indications.

Such factors include:

1. seed formation and maturity,
2. specific features of a given grain,
3. degree of contamination and screenings,
4. degree of damage caused by pests and fungi.

#### **NOTE!**

Please remember, results of measurements should be compared only with the laboratory drying-and-weighing test, not with results of other moisture meters, as they may be misleading.

The Draminski GMS grain moisture meter enables the user to modify (adjust) measurement indications.

In any case of modification, each grain type is treated individually. When a modification is made, an asterisk (\*) will be displayed next to the grain name, while during the measurement, a note will be displayed in the upper right corner of the screen, showing the value of adjustment of indication for a given grain (the result will automatically reflect the modification):

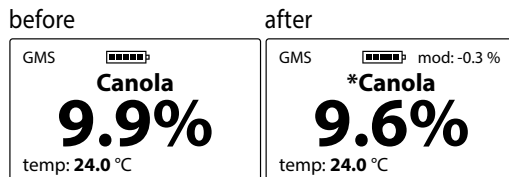

It is recommended to restore factory settings in each following year and make another adjustment of indications (modification) if required.

When factory settings are restored, the asterisk (\*) next to the grain name disappears.

**For a step-by-step guide for modification of moisture indications see SETTINGS section.**









# SETTINGS

EN

## SECTION 10

Functions included in the main menu of the device enable the user to switch off the device quickly, adjust settings to individual needs, add new species and much more. **In order to access the MAIN MENU, hold  button for 2 seconds.**



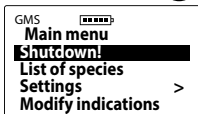

## 1. Shutdown!

To switch off the device, go to the **Main Menu** using the , then using  or  choose **Shutdown!** and confirm by .



This function allows the user to switch the device off in a quick and comfortable way, without the necessity to hold  for 5 seconds or to wait until the automatic shutdown option activates.

## 2. List of species

To return to the list of species from the **Main Menu**, use , or with the help of  or  select **List of species** and confirm with  button.

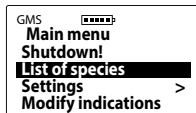

## 3. Settings

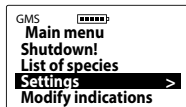

### 3.1. International:

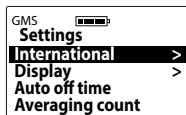

3.1a) language – to change a language version, go to **Main menu / Settings / International / Language**, then select a language version with (v) or (^) buttons and confirm by (OK) button, e.g.:



3.1b) temperature scale – to change temperature from Celsius to Fahrenheit or vice versa, go to **Main Menu / Settings / International / Temperature scale**, then select proper scale using (v) or (^) buttons and confirm by (OK) button, e.g.:



## 3.2 Display



3.2a) backlight intensity - the device has an energy-saving LED-backlit display; however, you should remember that setting stronger backlight results in faster battery discharge. To change display backlight intensity, go to **Main menu / Settings / Display / Backlight intensity**, then select a proper value using (v) or (^) buttons and confirm by (OK) button, e.g.:

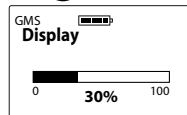

3.2b) backlight time – adjust the time after which the display backlight turns off until any button is pressed again (the time is measured after the last use of any keyboard button). To modify backlight time, go to **Main menu / Settings / Display / Backlight time**, select required value using  $\downarrow$  or  $\uparrow$  buttons and confirm with  $\text{OK}$  button, e.g.:

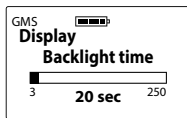

### 3.3 Auto off time

Adjustment of time after which the device shuts down automatically, starting from the last use of any keyboard button. To change the automatic shut-down time, go to **Main menu / Settings / Auto off time**, select required value using  $\downarrow$  or  $\uparrow$  buttons and confirm with  $\text{OK}$  button, e.g.:

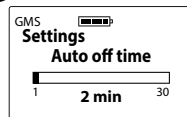

3.2c) contrast – in order to change display contrast, go to **Main menu / Settings / Display / Contrast**, select required value using  $\downarrow$  or  $\uparrow$  buttons and confirm with  $\text{OK}$  button, e.g.:

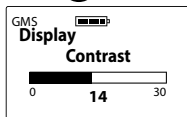

### 3.4 Averaging count

The device automatically calculates the average of recent measurements. In order to determine how many measurements should be included in the average, go to **Main menu / Settings / Averaging count**, select required number using  $\downarrow$  or  $\uparrow$  buttons and confirm with  $\text{OK}$  button, e.g.:

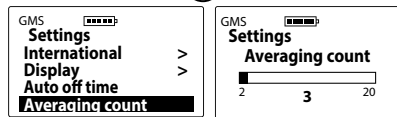

The average value will appear in the bottom right corner of the screen (after the third measurement, if the averaging count is set to „3“), e.g.:

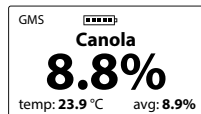

### NOTE!

To clear the average value, hold  $\downarrow$  button until the device displays „Clear average?“. Press  $\text{OK}$  to confirm, or  $\text{ESC}_{\text{on/off}}$  to cancel (the average will also clear if you return to the list and select another species).

### 4. Modifying moisture indications

**Before modifying (adjusting) moisture indications, read MODIFICATION OF MOISTURE INDICATIONS section.**

To modify indications for a given type of grain, go to **Main menu / Modify indications**, use  $\downarrow$  or  $\uparrow$  button to select grain to be modified and determine the value of moisture indication increase or decrease. Confirm your selection with  $\text{OK}$  button, e.g.:

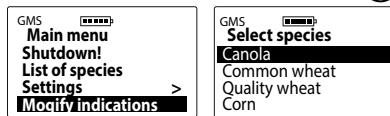

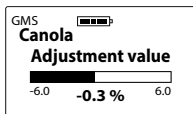

When modification is made, an asterisk (\*) appears next to the grain name, informing on the alteration of factory settings. During the measurement, the modification value will be displayed in the upper right corner of the screen, e.g.:

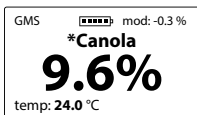
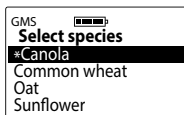

To restore factory settings, set the modification value to "0.0%", the asterisk beside the grain name will disappear:

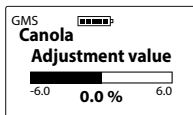

## 5. Add species

Before adding a new type of grain, see LIST OF AVAILABLE SPECIES AND ADDING NEW TYPES OF GRAIN.

To add a new type of grain to the list installed in the device, go to **Main menu** using **ESC** (on/off), then select **Add species** option using **↓** or **↑** buttons and confirm with **OK** button, e.g.:

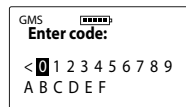



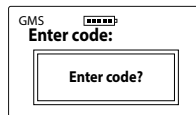

To enter the special code, select appropriate characters using **↓** or **↑** buttons and confirm with **OK** ((use „<“ to delete characters, confirm with **OK**)).

When all characters are entered, the device will ask for confirmation. Press **OK** to confirm, e.g.:



**Caution!** Re-entering the same code will result in removing the given grain type from the list available in the device. Codes are dedicated for one device – to activate a new grain type in two GMM mini moisture meters, you will need two different codes.

## 6. Information

In order to check device data and contact details of the manufacturer, go to **Main menu** using , and select the option **Information** using  or  buttons. Press  to confirm.

This option allows the user to view the device model, firmware version, serial number and (on page 2) address and contact details of the manufacturer, DRAMIŃSKI S.A.







# BATTERY REPLACEMENT

EN

## SECTION 11

The device gives an automatic warning when batteries are discharged. In such case, immediately after switch-on or during the use a graphic symbol will display, which means “**Change battery**”. After that, the GMM mini will switch off automatically.

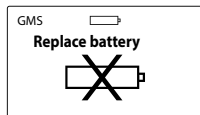

The grain moisture meter is supplied with one battery type 6LF-22, 9V.

**In order to change the battery:**

- unlock the battery compartment cover on the underside and remove discharged battery;
- install new battery according with its polarity signs +/-
- close the battery compartment with the cover. Press it carefully until it locks with a click, which indicates that the battery compartment is properly secured and there is no risk of the battery falling out.



# FINAL NOTES

EN

## SECTION 12

- after each measurements clean the measuring chamber fast and carefully (especially if the sample was wet), it will help your device work properly and for a long time,
- protect your grain moisture meter against direct exposure to water. Avoid operating the device in extreme temperatures. Do not allow moisture condensing out of the air to accumulate on metal parts of the device, as it may affect measurements,
- at the end of the season, clean and dry the measuring chamber carefully. Leaving the device dry guarantees long and reliable operation,
- store the device in dry and warm conditions,
- before any prolonged storage, remove batteries from their compartment in order to eliminate the risk of damage caused by battery leak. We recommend using batteries of leading manufacturers,
- in case of any problems with the device or difficulties in interpretation of the results, please contact the manufacturer DRAMIŃSKI S.A. or your local authorised distributor before sending the device for repair.
- do not dismantle the device on your own. Any modifications or repairs performed by unauthorised persons are unacceptable, as they may result in permanent damage and void the warranty,
- always check if the mini-USB port rubber cap is in place, otherwise dirt might get inside and cause damage.

# TECHNICAL DATA

EN

## SECTION **13**

<b>Approximate weight of device</b>	1015 g (with knob and battery)
<b>Approximate dimensions</b>	20.0 x 10.0 x 7.5 cm (without knob)
<b>Power source</b>	1 battery, type 6LF-22.9V
<b>Current battery status indicator</b>	graphic
<b>Battery discharge notification</b>	automatic
<b>Power consumption</b>	from 6.5 mA to 8 mA (depending on set backlight intensity)
<b>Approximate length of continuous work on one set of batteries</b>	85 hours, with backlight intensity set to 0% / 50 hours with backlight intensity set to 30%
<b>Moisture measurement method</b>	resistance
<b>Measurement control</b>	single-chip microcomputer
<b>Measurement chamber filling method</b>	manual, using a dedicated dispenser
<b>Sample volume</b>	10 ml
<b>Moisture measurement accuracy</b>	±0.5% for normalized grain, ±1.0 % in range up to 10 %, ±1,2 % in range above 10 % and may increase along with sample moisture
<b>Temperature measurement range</b>	from -10 °C up to + 85 °C / from 14 °F up to 185 °F
<b>Temperature indication resolution</b>	0.1 °C / 0.1 °F
<b>Temperature indication accuracy</b>	±0.5 °C / ±0.9 °F
<b>Display</b>	graphic LCD with LED backlight, display size 2"
<b>Keyboard</b>	membrane
<b>Update</b>	through USB
<b>Data storage</b>	internal memory
<b>Additional functions</b>	moisture indications modification, adding new species by entering special codes, calculating average value, automatic temperature compensation, pop-up menu, display parameters setting, language version selection, temperature scale selection, auto-off time adjustment, data and firmware update
<b>Recommended operating temperature range</b>	from 10 °C up to 35 °C / from 50 °F up to 95 °F
<b>Recommended storage temperature</b>	from 5 °C up to 45 °C / from 41 °F up to 113 °F

[www.draminski.com](http://www.draminski.com)



**DRAMIŃSKI S.A.**

Owocowa 17, 10-860 Olsztyn, Poland

phone: +48 89 572 11 30, fax +48 89 527 84 44

e-mail: [wilgo@draminski.com](mailto:wilgo@draminski.com)

Instr. GMS1016EN1.0